

LW30-20、25、32

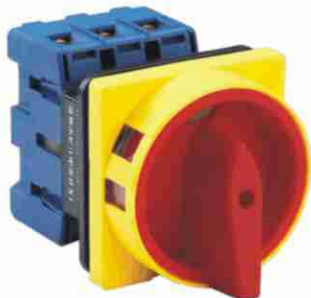

LW30-40、63



◆ 产品简介 Introduction

LW30系列万能转换开关主要用于交流50Hz，额定工作电压440V以下，额定电流至100A的电气线路中，用作通风设备、空调和水泵系统的主开关，亦可直接控制小容量交流电动机。

产品符合标准GB 14048.3及IEC 60947-3。

LW30系列开关规格齐全，有20A、25A、32A、40A、63A、80A和100A等电流等级。

LW30系列开关具有体积小，结构紧凑，选材讲究，绝缘良好，具有护指功能，安全可靠，可以在3极的标准块上加上其它的触点块而不必拆除此开关。

LW30系列开关绝缘距离大于同类其它开关，断开速度快，适用于直流开关。

LW30 series rotary switches applied to circuits of AC 50Hz with working voltage up to 440V and rated working current up to 100A.

LW30 is suitable to control: air-conditioner, water pump and ventilating equipments, and AC motors with small power.

LW30 series rotary switches have six current ratings: 20A, 25A, 32A, 40A, 63A, 80A and 100A.

LW30 series has the finger protection terminals, which offers an extra advantage.

LW30 series switches has Larger insulation distance, quick disconnecting response. And is a good choice For DC circuits. LW 30 has additional contact which enable us to install the contact separately

LW30 series rotary switches comply with: GB/T 14048.3, and IEC 60947-3.

正常工作条件 Working conditions

- (1) 周围空气温度不超过 +40℃，且其 24 h 内的平均温度不超过 +35℃；
Ambient temperature Do Not exceed 40℃, and the average temperature, measured over a period of 24 hours, Do Not exceed 35℃.
- (2) 周围空气温度的下限不超过为 -25℃；
Ambient temperature should not be below -25℃.
- (3) 安装地点的海拔不超过2000 m；
Should Not be installed over 2000m above sea level.
- (4) 最高温度为 +40℃时，空气的相对湿度不超过50%，在较低的温度下可以允许有较高的相对湿度，例如20℃时达90%。对由于温度变化偶尔产生的凝露应采取特殊的措施。
The humidity should not exceed 50% when the ambient temperature is 40℃ and higher humidity is allowed for lower temperature.

安装条件 Installation conditions

- (1) 开关安装在污染等级3的环境条件；
A clean environment is required.
- (2) 根据本厂提供的说明书进行安装。
Please follow our manual.

分类 Classification

1.按使用类别分 Classified by utilization

- (1) AC-23A
- (2) AC-3

2.按所提供的防护等级分 Classified by protective level

- (1) 不带开关盒 Without plastic box: IP2L0
- (2) 带热塑密封开关盒 With plastic box: IP65

LW30-80、100



产品型号及其含义 Designation

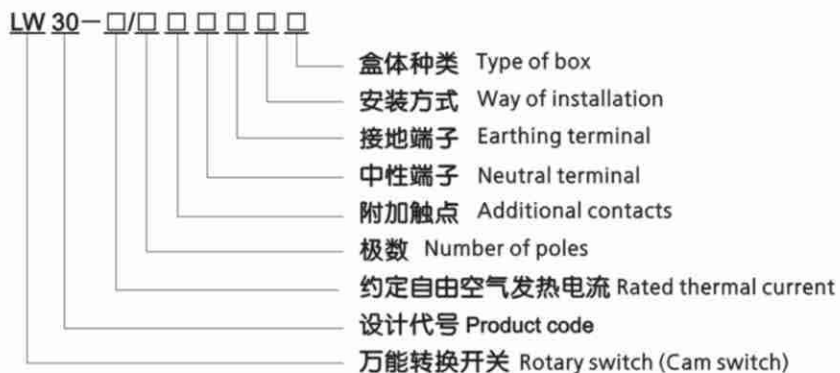

辅助规格代号 Accessorial code:

极数: 3 三极, 4 四极

Number of poles: 3P, 4P

附加触点: 0 不带, 1 带侧面安装辅助触点

Additional contacts: 0 for additional contacts not inclosed, 1 for with additional contacts

中性端子: 0 不带, 1 带中性端子

Neutral terminal: 0 for neutral terminal not inclosed, 1 for with neutral terminal.

接地端子: 0 不带, 1 带接地端子

Earthing terminal: 0 for earthing terminal not inclosed, 1 for with earthing terminal.

安装方式 Installation:

1 带挂锁面板安装 Pad-lock escutcheon plate

2 面板安装 Escutcheon plate

3 单挂锁导轨安装 Single lock parallel installation

4 带挂锁把手/门互锁底座安装 Doorlock safety switch with Padlock system

5 单孔 Single hole installation

盒体种类: 0 不带, 1 带防护等级为IP65的热塑密封盒

Type of box: 0 without protective box, 1 with IP65 Plastic box

面板规格 Escutcheon plate



手柄类型 Type of handle



附件 Accessories



辅助触头和可选附件 Auxiliary contact & Optional accessories



◆ 技术参数 Technical parameters

型号规格 Description		LW30-25(20)	LW30-32	LW30-40	LW30-63	LW30-80	LW30-100
约定发热电流 Rated thermal current I _{th}	A	25(20)	32	40	63	80	100
额定工作电压 Rated working voltage U _e	V	240 440	240 440	240 440	240 440	240 440	240 440
额定值 Rated value	I _e /P _e						
AC-21A	A/kW	20/- 20/-	32/- 32/-	40/- 40/-	63/- 63/-	80/- 80/-	100/- 100/-
AC-22A	A/kW	20/- 20/-	32/- 32/-	40/- 40/-	63/- 63/-	80/- 80/-	100/- 100/-
AC-23A	A/kW	15/4 15/7.5	22/5.5 22/11	30/7.5 30/15	43/11 43/22	57/18.5 57/30	70/22 70/37
AC-3	A/kW	11.7/3 11.7/5.5	15/4 15/7.5	22/7.5 22/11	36/11 36/18.5	43/15 43/22	57/18.5 57/30

电流种类：交流50Hz

Current type: 50Hz AC

主触头位置数：ON或OFF二位置

Number of main contact: ON and OFF

额定工作制：8小时工作制/断续周期工作制，操作频率为30次/h。

Frequency: 8 hours per day, 30 times per hour

电寿命：AC-23时为10000次，AC-3时为6000次，辅助触头为2000次。

Mechanism Life: 10000 times/AC-23, 6000 times/AC-3, 2000 times for additional contact.

订购方法

在订购LW30开关时，需以下的数据：

1. 开关额定值：如LW30-20；

2. 辅助规格，依次填写。

(1) 极数：如3；

(2) 带否附加触点：0不带，1带；

(3) 带否中性端子：0不带，1带；

(4) 带否接地端子：0不带，1带；

(5) 安装方式：

1 (带挂锁面板安装)；

2 (面板安装)；

3 (单挂锁导轨安装)；

4 (带挂锁把手/门互锁底座安装)；

5 (单孔)；

(6) 箱体种类：如0 (不带)；1 (带箱体)。

3. 除了上述1.2型号规格外，附加了以下代号利于选用订购：

(1) 面板规格代号：1代表面板安装；

2代表φ22.5孔安装；

3代表φ25孔安装；

4代表φ30.5孔安装

(2) 面板是否带密封：0不带；1带

(3) 面板底色：1代表暗银底；2代表黄色底，3代表指定色。

(4) 刻字代表数字：2代表字母；3代表文字；4代表特殊标记；

(5) 在第4位附加代号中注明手柄代号：如R或I或K，若不注时按常用I型提供。

4. 除了上述1.2.3以外，有特殊要求，请与我们联系。

例1：40A/3极带附加触点，不带中性端子，带接地端子，面板安装，不带开关盒。表示为：LW30-40/310120

例2：32A/3极带门互锁底座安装。表示为：LW30-32/300030

例3：40A/3极带附加触点，不带中性端子，带接地端子，面板安装，不带开关盒，面板安装，密封轴，黄色底，汉字，K型手柄。表示为：LW30-40/310120.1123K

Order Procedurer

When you order our LW30 series, We need your data as following

1. Rated working current, for example:LW30-20;

2. Accessorial code, please write it orderly

(1) Number of poles, for example: 3P;

(2) Do you need additional contacts: 0 not inclosed, 1 inclosed.

(3) Do you need neutral terminal: 0 not inclosed, 1 inclosed;

(4) Do you need earthing terminal: 0 not inclosed, 1 inclosed;

(5) Way of installation:

1 Escutcheon plate with pad-lock

2 Escutcheon plate

3 Single lock parallel installation

4 Doorlock safety switch with Padlock system

5 Single hole installation

(6)Type of box: 0 not inclosed, 1 inclosed.

3. Other accessorial code, please write it orderly

(1) Type of Escutcheon plate: 1 Escutcheon plate;

2 Denote φ22.5 hole;

3 Denote φ25 hole;

4 Denote φ30.5 hole.

(2) Do you need Escutcheon plate with airproof: 0 Not inclosed it, 1 inclosedn it

(3) Colour of bottom plate: 1 Denote silver color; 2 Denote yellow;

3 Make it against your color

(4) Character letter: 1 denote letter; 2 Chinese letter; 3 Special sign

(5) Code of handle: R or K or I

For example:

If you order 40A/3P with additionalcontacts and earthing terminal and Escutcheon plate without neutral terminal and plastic box.

You must write: LW30-40/310120

If you want to order 32A/3 with Doorlock safety switch,

You must write: LW30-32/300040.

If you want to order 40A/3 with adding contacts, earthing terminal, Escutcheon plate, plate with airproof, Yellow, Chinese letter, K handle; without neutral terminal and plastic box. You must write: LW30-40/310120.1123K

◆ 外形尺寸和安装尺寸 Dimensions and installation

面板安装 Panel installation

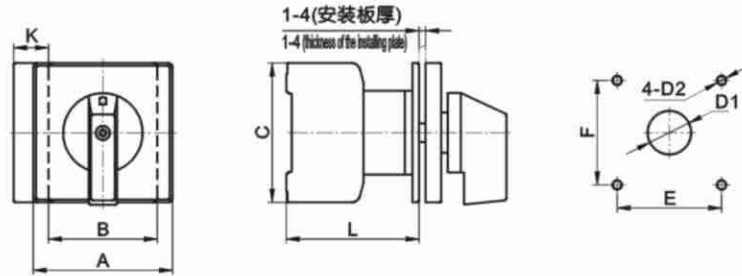

型号规格 Description	外形尺寸 Dimensions(mm)					安装尺寸 Installation(mm)			
	A	B	C	K	L	E	F	D1	D2
LW30-20	□64	42	54	13.5	61	48	48	∅10	∅4.2
LW30-25	□64	42	54	13.5	61	48	48	∅10	∅4.2
LW30-32	□64	42	54	13.5	61	48	48	∅10	∅4.2
LW30-40	□64	50	64	16	67	48	48	∅10	∅4.2
LW30-63	□64	50	64	16	67	48	48	∅10	∅4.2
LW30-80	□64	70	80	22.5	82	48	48	∅10	∅4.2
LW30-100	□64	70	80	22.5	82	48	48	∅10	∅4.2

底座安装 Base installation

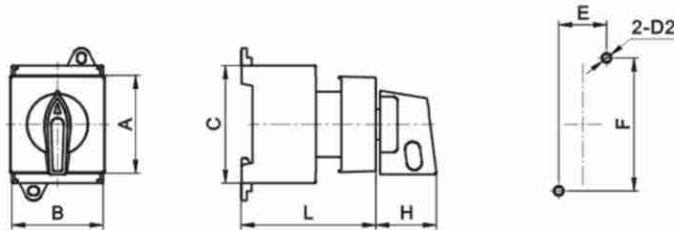
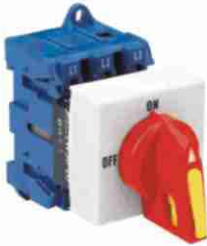

型号规格 Description	外形尺寸 Dimensions(mm)					安装尺寸 Installation(mm)		
	A	B	C	L	H	E	F	D2
LW30-20	45	42	54	50	26	22	60	∅4.2
LW30-25	45	42	54	50	26	22	60	∅4.2
LW30-32	45	42	54	50	26	22	60	∅4.2

注：底座可以安装在35mm标准导轨上。
Re: Product can be installed in 35mm parallel.

单孔安装 Single hole installation

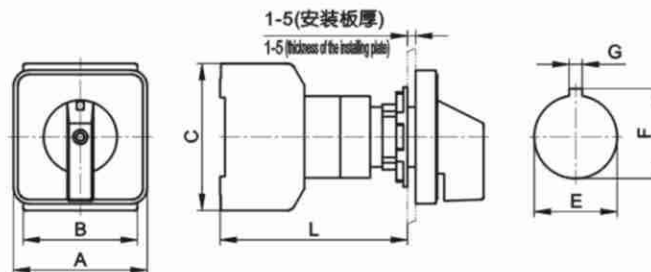

型号规格 Description	外形尺寸 Dimensions(mm)				安装尺寸 Installation(mm)		
	A	B	C	L	E	F	G
LW30-20	□49	42	54	69	∅22.3	24.1	3.2
LW30-20	□64	42	54	69	∅22.3	24.1	3.2
LW30-25	□49	42	54	69	∅22.3	24.1	3.2
LW30-25	□64	42	54	69	∅22.3	24.1	3.2
LW30-32	□49	42	54	69	∅22.3	24.1	3.2
LW30-32	□64	42	54	69	∅22.3	24.1	3.2

带门锁的底座安装 Installation of doorlock safety switch

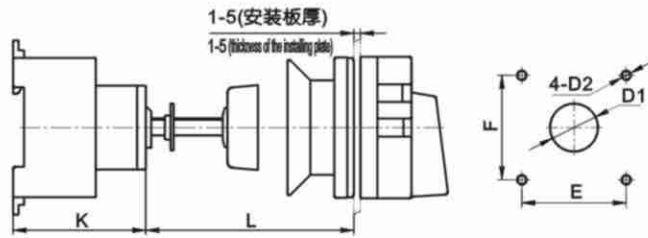

型号规格 Description	外形尺寸 Dimensions(mm)			安装尺寸 Installation(mm)			
	K	Lmin	Lmax	E	F	D1	D2
LW30-20	50	32	150	48	48	∅22	∅4.2
LW30-25	50	32	150	48	48	∅22	∅4.2
LW30-32	50	32	150	48	48	∅22	∅4.2
LW30-40	61	32	150	48	48	∅22	∅4.2
LW30-63	61	32	150	48	48	∅22	∅4.2
LW30-80	68	32	150	48	48	∅22	∅4.2
LW30-100	68	32	150	48	48	∅22	∅4.2

注：底座可以安装在35mm标准导轨上。
Re: Product can be installed in 35mm parallel.

防护罩 Protective cover

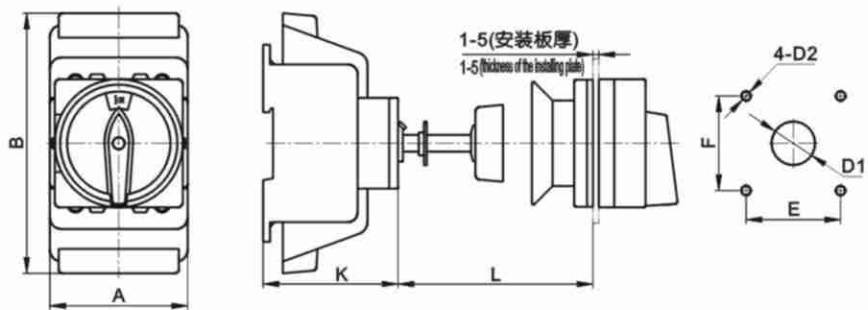

型号规格 Description	外形尺寸 Dimensions(mm)					安装尺寸 Installation(mm)			
	A	B	K	Lmin	Lmax	E	F	D1	D2
LW30-80	70	133	68	32	150	48	48	∅22	∅4.2
LW30-100	70	133	68	32	150	48	48	∅22	∅4.2

热塑密封盒 Plastic box

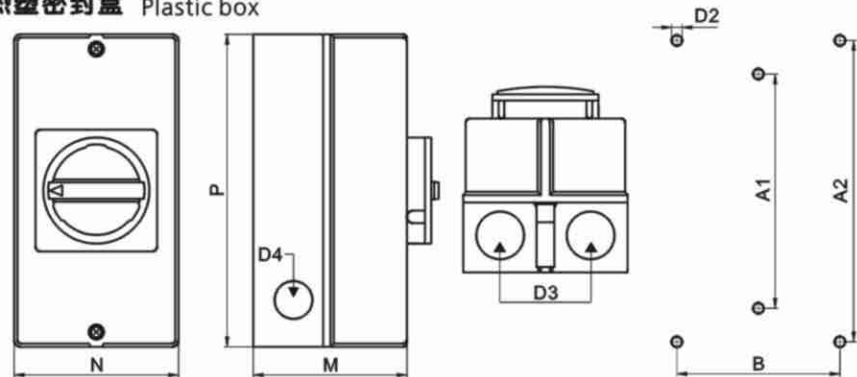

型号规格 Description	外形尺寸 Dimensions(mm)					安装尺寸 Installation(mm)			
	D3	D4	M	N	P	A1	A2	B	D2
LW30-20	∅23	∅19	85	83	160	150	--	--	∅4.2
LW30-25	∅23	∅19	85	83	160	150	--	--	∅4.2
LW30-32	∅23	∅19	85	83	160	150	--	--	∅4.2
LW30-40	∅29	∅23	100	95	190	178	--	--	∅4.2
LW30-63	∅29	∅23	100	95	190	178	--	--	∅4.2
LW30-80	∅37.5	∅23	144	105	250	--	229	124	∅6.5
LW30-100	∅37.5	∅23	144	105	250	--	229	124	∅6.5